

ALUMINUM™
FENCE SUPPLY

"The Superior Alternative"



CLASSIC SERIES™



Aluminum Fence Supply

CLASSIC SERIES™

"The Superior Alternative"

Experience The Difference

- ◆ **Made in The USA**
- ◆ **DuPont™ Platinum Certified Alesta® Applicator**
- ◆ **Superior Powder Coated Strength**
- ◆ **Meets or Exceeds AAMA 2604-10 Specifications**
- ◆ **Meets International Code Council Pool Code**
- ◆ **Cutting-Edge Technology**
- ◆ **6 Unique Grades**
- ◆ **7 Rich Colors**
- ◆ **True Height Panels and Posts**
- ◆ **Custom Services**
- ◆ **Quick Ship Program**
- ◆ **Nation-Wide Network**
- ◆ **Unmatched Service**
- ◆ **Limited Lifetime Warranty**

The Obvious Choice...

William Woodard, an experienced small business owner and entrepreneur, began manufacturing fence products in early 2000. Today, the Aluminum Fence Supply product line includes a large selection of maintenance-free fence, railing, and gates that are manufactured to withstand some of the harshest conditions. Located in a state-of-the-art manufacturing facility in Brooksville, Florida, Aluminum Fence Supply products are available in all fifty states and Canada.

Since 2010, our powder coating process has been certified DuPont Platinum in AAMA 2604, making us one of only a few powder coaters in the United States to have received this coveted honor. This is the highest level of certification available to architectural applicators.

We make every effort to concentrate our business with domestic companies including our primary aluminum extrusion suppliers in the Southeast and DuPont powder, which is made in Texas. As a domestic manufacturer, we're proud to say that everything we produce - including all panels, posts, and gates - are made right here at home. So know that when you choose an Aluminum Fence Supply product, you're also choosing an American company that manufactures quality, American made products.

All Aluminum Fence Supply Products are
Manufactured in the United States of America





Table of Contents

Classic Series	2
About Aluminum Fence Supply	3
Flat Top	4
Pressed Spear	5
Premier	6
Enhancements (Radius, Arbor, Custom)	7
Pedestrian Gates (Walk & Pool)	8
Estate Gates (Swing & Cantilever)	9
Security	10
Chain Link Cantilever	11
Guardrail	12
Handrail	13
Privacy	14
Post and Rail	15

If You Can Dream It...

...We Can Build It! In addition to an expansive line of products, We also offer professional Custom Design Services. Products include radius, convex/concave, and transitional panels as well as custom picket spacing, colors, channels, and heights. Unique gate designs, personalized gate adornments, and creative fence designs are also available.

A custom Aluminum Fence Supply project begins and ends with a customer's vision. With a talented team of representatives, engineers, designers, and skilled craftsmen, we can create unique, innovative and custom solutions for almost any situation or to any specification. So when you're choosing an Aluminum Fence Supply product, remember, "If You Can Dream It, We Can Build It."

We Think in Green...

As an environmentally aware company, we take great pride in our facility's recycling efforts. We recycle 100% of all aluminum, paper and plastic scrap. We also recycle 90% of evaporate coolant water and sell 99% of our reclaimed powder from our powder coating line to local businesses, resulting in a 1% waste factor. We will continue to explore Green Practices to reduce, recycle or eliminate waste generated every day.



A Nation-Wide Network

Our state-of-the-art manufacturing facility in Brooksville, Florida provides 200,000 square feet of manufacturing space. Our experienced Customer Service Representatives and Territory Managers service all fifty states as well as Canada. With resources throughout the United States, as well as a nation-wide network of dealers, we can accommodate all of your fencing needs.



FLAT TOP



Styles

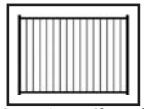

Series A • 2-Channel

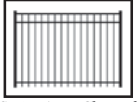

Series A • 3-Channel

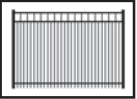

Series A • Double Picket

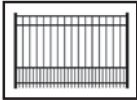

Series A • Puppy-Picket

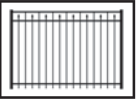

Series C

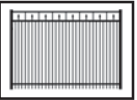

Series C • Double Picket



Series C • Puppy-Picket

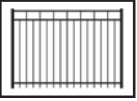

Series F

Series A • Series C • Series F

ADVANTAGES:

- Classic and Versatile
- Decorative
- Property Boundary
- Safety Barrier
- 6 Unique Grades
- 7 Rich Colors
- True Height Panels & Posts

Grades: Channels & Pickets

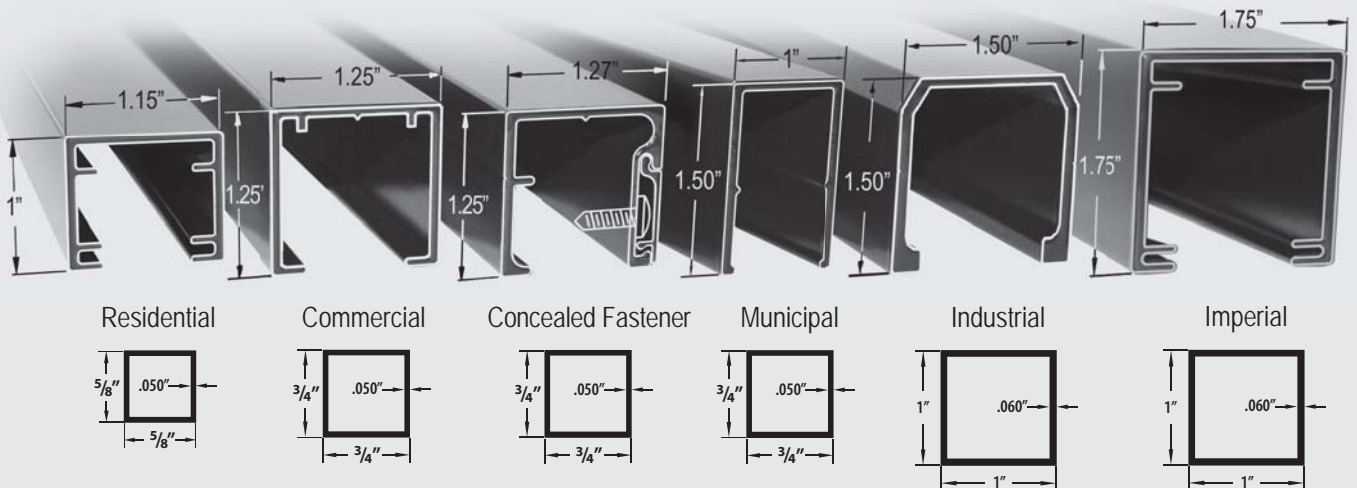

~ Channels & Pickets are shown at 3/5 actual size

PRESSED SPEAR

Series B • Series H

ADVANTAGES:

- Aesthetic Security •
- Decorative •
- Deters Pedestrian Scaling •
- Perfect for Estates •
- 6 Unique Grades •
- 7 Rich Colors •
- True Height Panels & Posts •

Styles

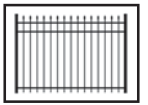

Series B

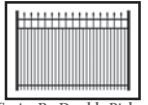

Series B • Double Picket

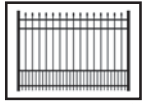

Series B • Puppy-Picket

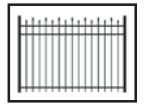

Series H

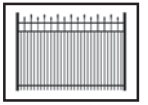

Series H • Double Picket

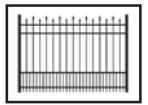

Series H • Puppy-Picket



Posts, Adornments & Colors

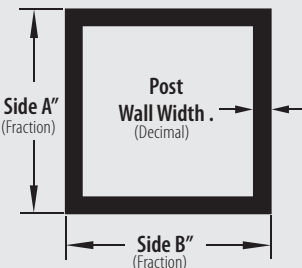

Post Measurements

2" x 2" x .062"	3" x 3" x .125"
2" x 2" x .093"	4" x 4" x .125"
2" x 2" x .125"	4" x 4" x .250"
2 1/2" x 2 1/2" x .075"	6" x 6" x .125"
2 1/2" x 2 1/2" x .125"	6" x 6" x .250"

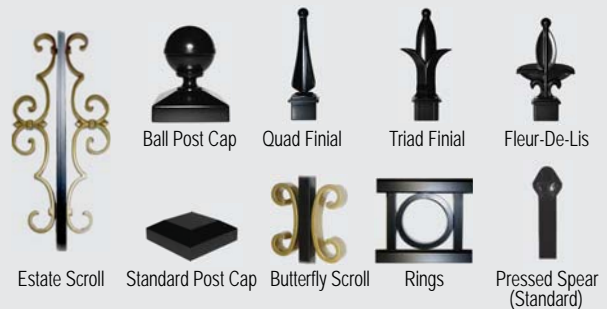

ALUMINUM
FENCE SUPPLY
"The Superior Alternative"



PREMIER

Styles

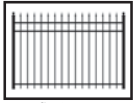

Series V

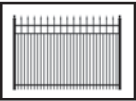

Series V • Double Picket

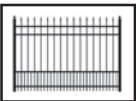

Series V • Puppy-Picket

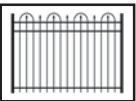

Series N1*

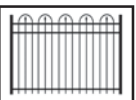

Series N2*

*Series N1 & Series N2 are Available in Residential Grade only.

Series V
Series N1 • Series N2

ADVANTAGES:

- Traditional, Old World Charm
- Decorative Safety Barrier
- Landscape Enhancing
- Ideal for Estates & Homes
- Quad, Triad, or Fleur-de-Lis Finials
- 6 Unique Grades
- 7 Rich Colors

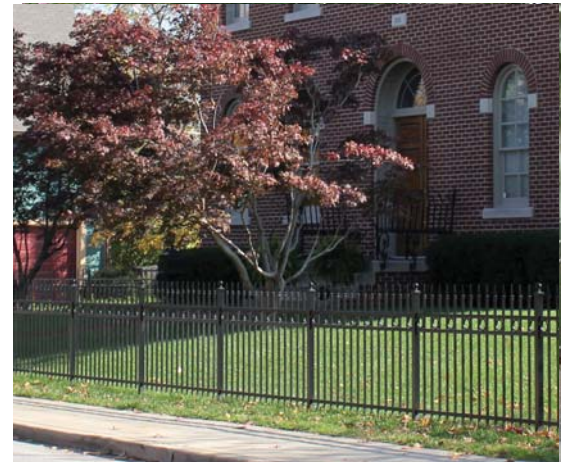

Grades: Channels & Pickets

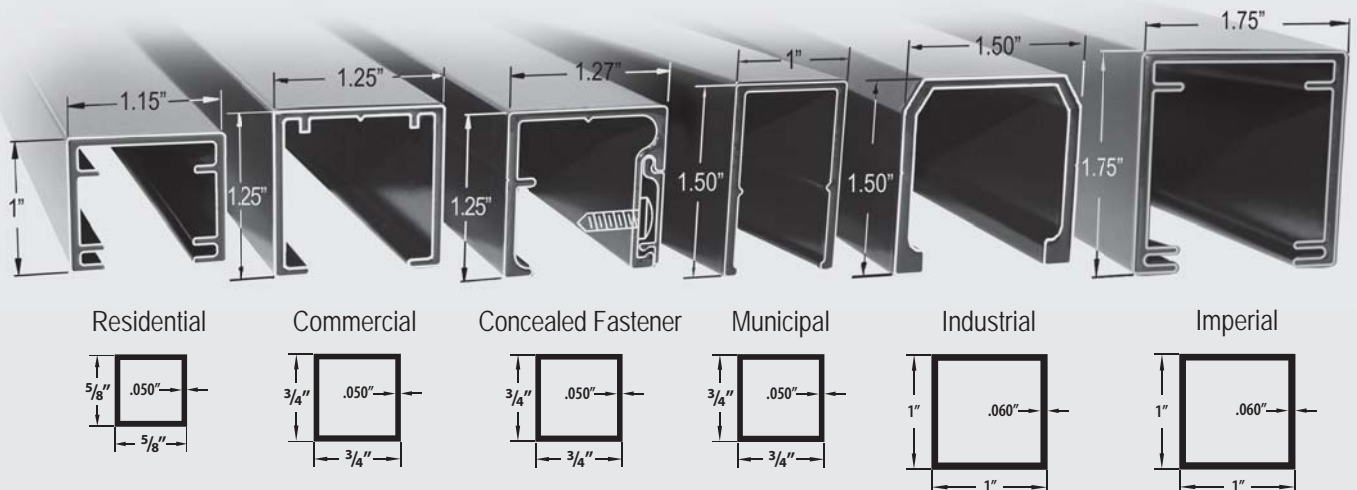

~ Channels & Pickets are shown at 3/5 actual size



ENHANCEMENTS

Radius Panel • The Arbor Custom Services

ADVANTAGES:

- “If You Can Dream it, We Can Build it”
- Crafted by Skilled Artisans & Engineers
- Personalized & Individual
- 6 Unique Grades
- Custom Colors Available
- Custom Radius Designs
- True Height Panels & Posts

Styles

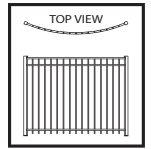

Radius Panels are available in all styles, heights & colors*

*Not Available in Concealed Fastener Grade



The Arbor is available in all grades, styles, heights & colors



Posts, Adornments & Colors

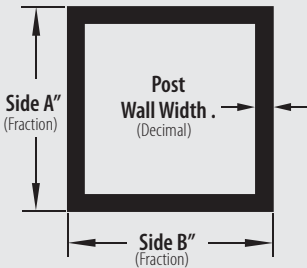

Post Measurements

2" x 2" x .062"	3" x 3" x .125"
2" x 2" x .093"	4" x 4" x .125"
2" x 2" x .125"	4" x 4" x .250"
2 1/2" x 2 1/2" x .075"	6" x 6" x .125"
2 1/2" x 2 1/2" x .125"	6" x 6" x .250"



~ Decorative, contrasting colored keystone & transition pieces are available for customizing The Arbor.

ALUMINUM
FENCE SUPPLY
“The Superior Alternative”

PEDESTRIAN GATES

Arches



Arch 01 Series



Arch 02 Series



Arch 03 Series

The heights below will meet the 45" spacing between channels required by ICC code

Series A
48" • 54" • 60" • 72"

Series C
54" • 60" • 72"

Series B
60" • 72"

Series H
60" • 72"

Series V
60" • 72"

POOL CODE
INFORMATION

Walk Gates Pool Gates

ADVANTAGES:

- Armor-Guard Powder Coating
- Complements The AFS Fence Line
- Pool Code Latches Available
- Multiple Adornment Options
- 6 Unique Grades
- 7 Rich Colors
- True Height Panels & Posts



Grades: Channels, Pickets & Posts

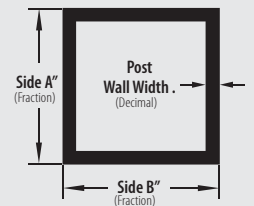
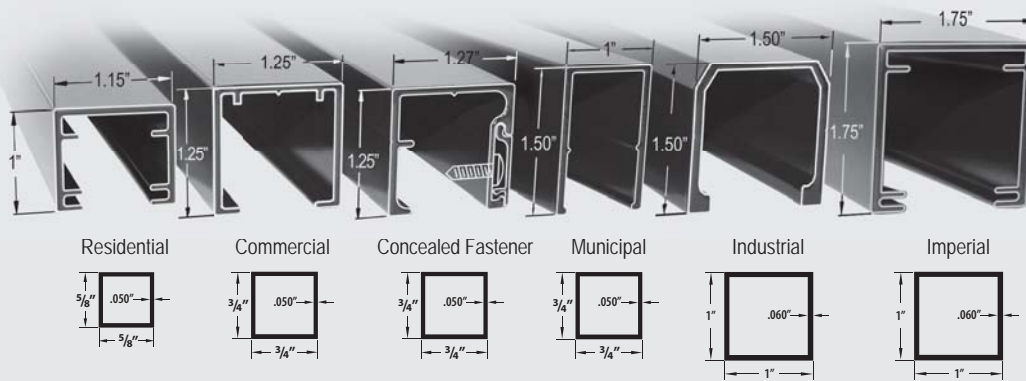

Post Measurements

2" x 2" x .062"	3" x 3" x .125"
2" x 2" x .093"	4" x 4" x .125"
2" x 2" x .125"	4" x 4" x .250"
2 1/2" x 2 1/2" x .075"	6" x 6" x .125"
2 1/2" x 2 1/2" x .125"	6" x 6" x .250"

~ Channels & Pickets are shown at 2/5 actual size

*Pool Code Fence & Gates are available in the following grades: Residential, Commercial, and Concealed Fastener. 48" Residential Series A 2-channel fence panels will meet the 45" channel spacing required by ICC code when ordered with a flush bottom. Please contact an Aluminum Fence Supply Representative for additional information regarding Pool Code Fence & Gate Specifications.

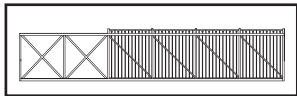

Arch 01 Series

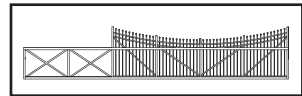

Arch 02 Series

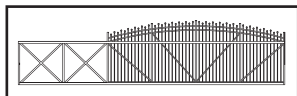

Arch 03 Series

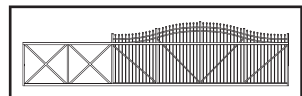

Arch 04 Series

ESTATE GATES

Swing Gates
Cantilever Gates

ADVANTAGES:

- Impressive, Elegant Functionality •
- Complements The AFS Fence Line •
- Armor-Guard Powder Coating •
- Hardware Included •
- Upgraded Hardware Available •
- Custom Gate Options •
- 6 Unique Grades* •

Arches

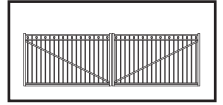

Arch 01 Series

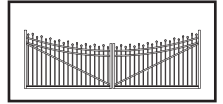

Arch 02 Series

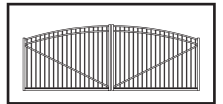

Arch 03 Series

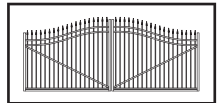

Arch 04 Series



Hardware, Adornments & Colors

Multiple Hardware Options are Available for All Gates in Addition to Those Shown Below



Estate Scroll



Ball Post Cap



Quad Finial



Triad Finial



Fleur-De-Lis



Standard Post Cap



Butterfly Scroll



Rings



Pressed Spear (Standard)

~ Decorative, contrasting colored keystone & transition pieces are available for customizing The Arbor.



~ Custom Colors Available

*Sliding Cantilever or V-Groove Gates are available in all styles of Commercial, Municipal, Industrial and Imperial Grade Fence.

ALUMINUM FENCE SUPPLY

"The Superior Alternative"



SECURITY

Styles

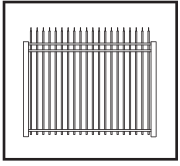

3 Channel

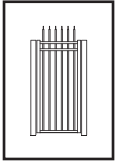

3 Channel Gate

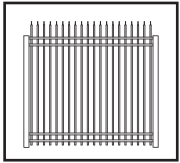

4 Channel

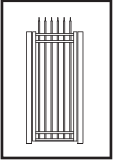

4 Channel Gate

3 & 4 Channel Styles Multiple Heights & Panel Sizes

ADVANTAGES:

- Achieves a High Level of Security
- Deterrent to Trespassers
- Industrial & Commercial Applications
- One of Our Heaviest Grades
- Withstands Above-Normal Abuse
- 7 Rich Colors
- True Height Panels & Posts



Grade: Channels, Pickets, Posts & Adornments

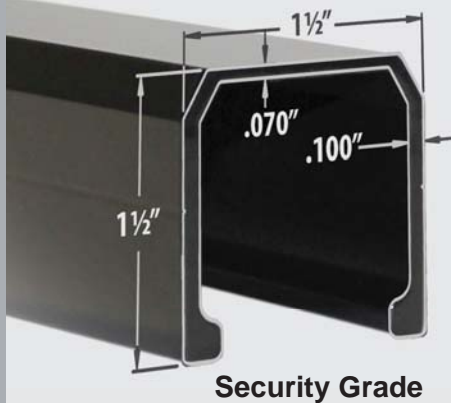

Security Grade

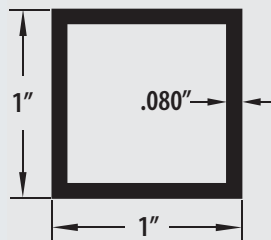

Security Picket

Post Measurements

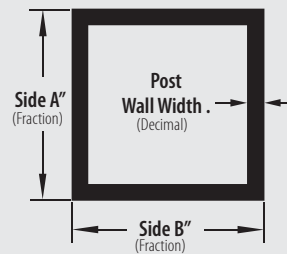

$2\frac{1}{2}'' \times 2\frac{1}{2}'' \times .075''$	$4'' \times 4'' \times .125''$
$2\frac{1}{2}'' \times 2\frac{1}{2}'' \times .125''$	$4'' \times 4'' \times .250''$
$3'' \times 3'' \times .125''$	$6'' \times 6'' \times .125''$
	$6'' \times 6'' \times .250''$

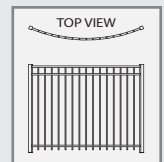

Radius Panel is Available in Security Grade

~ Security Channel & Picket are Actual Size.
Post image is a representation only.

Chain Link CANTILEVER

Single or Double Track
Multiple Heights & Lengths

ADVANTAGES:

- Adds a High Level of Security
- Deters Trespassers
- Industrial & Commercial Applications
- Strong, Hand-Crafted Framework
- Chain Link, Wood, & Vinyl Inserts
- Optional Barbed Wire Top
- Armor Guard Powder Coating
- Multiple Track Options & Sizes
- 7 Rich Colors

Style Examples

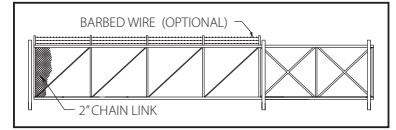

288" CANTILEVER • 6' CHAIN LINK

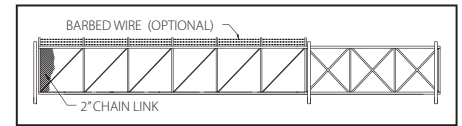

384" CANTILEVER • 6' CHAIN LINK



Details & Colors

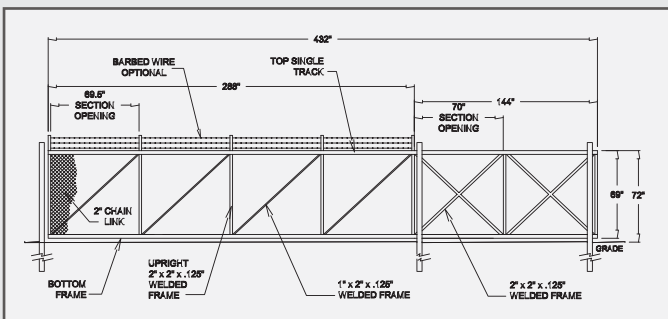

Chain Link Cantilever Gate
(Detailed Example)

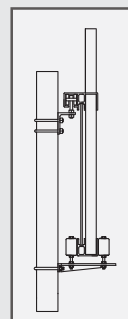

Track & Trolley
Assembly
(Single)

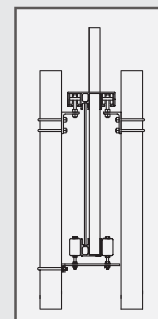

Track & Trolley
Assembly
(Double)

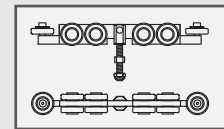

Detail - Trolley Assembly

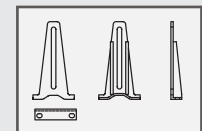

Wheel Guide Bracket



ALUMINUM
FENCE SUPPLY

"The Superior Alternative"



GUARDRAIL

Components



Welded Flange



End Brackets



Intermediate Bracket



Vertical Swivel



Horizontal Swivel



Decorative End Cap

Bottom Rail Insert



2" & 2 1/2" Side Mount Flanges

ADVANTAGES:

- Complements a Variety of Architectural Styles
- Commercial & Residential Applications
- Meets Strict Safety Codes in All 50 States
- Meets Standard Specs Including Pool Code
- Durable & Easy to Install
- Available in Multiple Heights
- Optional Adornments
- Beveled Rails for Strength
- 7 Rich Colors

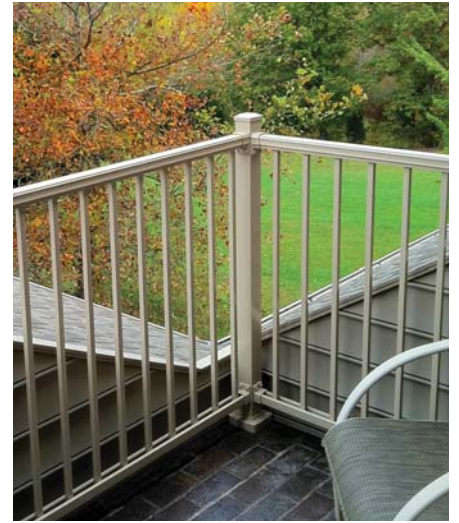

Posts, Picket & Details

End Post
2 1/2" x 2 1/2" x .125"

Intermediate Post
2" x 2" x .125"

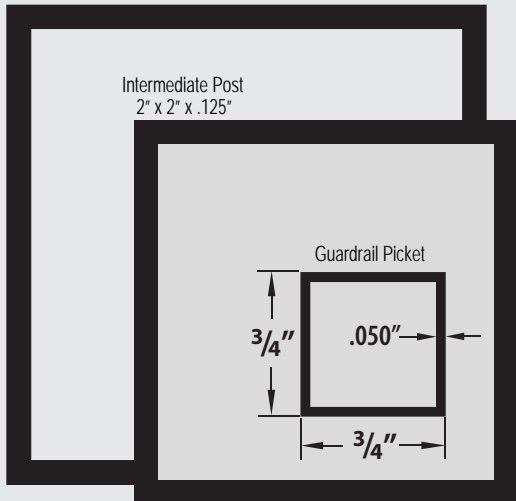

Guardrail Channels & Fasteners

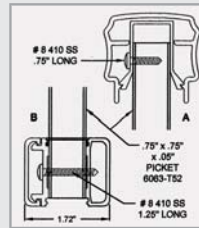

Intermediate Bracket

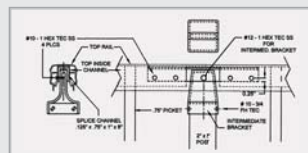

Guardrail Details

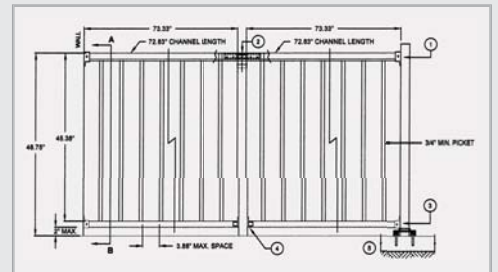

~ Railing Posts & Picket are shown actual size.

HANDRAIL

ADVANTAGES:

- May be Used for a Variety of Applications
- Americans With Disabilities Act Compliant
- Meets or Exceeds All Safety Codes
- Ensures Pedestrian Safety
- Complements The AFS Guardrail System
- Adaptable To Most Existing Posts or Walls
- Durable & Easy to Install
- Available in Straight & Angled with 180° Return
- 7 Rich Colors

Components



Straight Splice



Wall Mount



Corner Mount



Wall Return



90° Coupling



Spacer



Collar Ring



Internal End Cap



Details, Adornments & Colors

Handrail Details

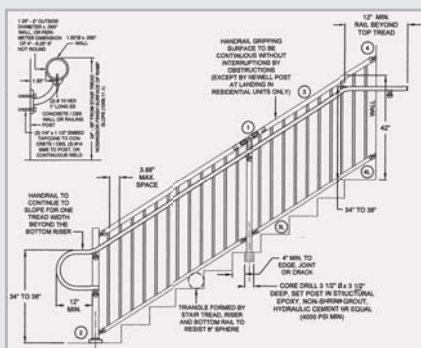

Intermediate Bracket

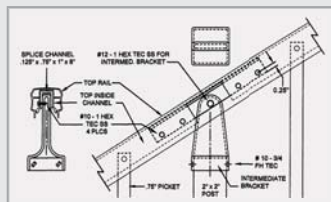

Estate Scroll



Rings - Double

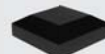

Standard Post Cap



Butterfly Scroll



ALUMINUM
FENCE SUPPLY

"The Superior Alternative"



PRIVACY

Styles

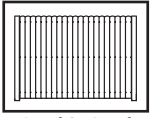

Board On Board



Board On Board Gate

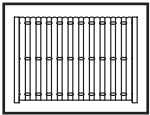

Shadowbox



Shadowbox Gate

Board on Board Shadowbox

ADVANTAGES:

- Reminiscent of the Old Wooden Privacy Fence
- Clear Boundary Definition
- Privacy & Protection
- Powder Coated Strength
- Durable & Long Lasting
- Maintenance Free
- 7 Rich Colors
- 6 foot & 8 foot Sections
- Heights up to 10 feet



Privacy Slat, Rail, Posts & Details

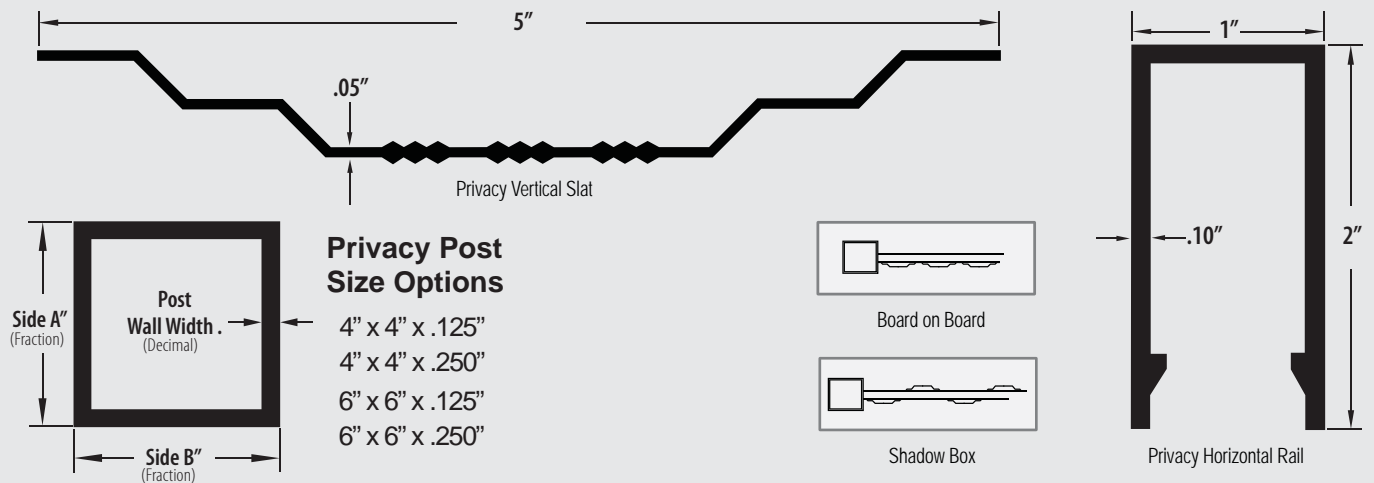

~ Privacy Vertical Slat & Horizontal Rail are shown Actual Size



POST AND RAIL

Two Rail • Three Rail
& Four Rail

ADVANTAGES:

- Reminiscent of the Old Split-Rail Fence
- Functional, Elegant and Simplistic
- Excellent for Livestock Containment
- Boundary Definition with a "Rural" feel
- Unobstructed View of Property
- Superior Powder Coated Strength
- 3 Styles Available in 8' Sections
- 7 Rich, Long-Lasting Colors
- Beveled Rails For Added Strength

Styles

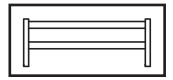

2-Rail

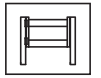

2-Rail Gate

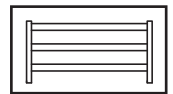

3-Rail



3-Rail Gate

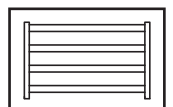

4-Rail



4-Rail Gate



Post and Rail Details & Colors

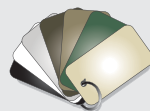
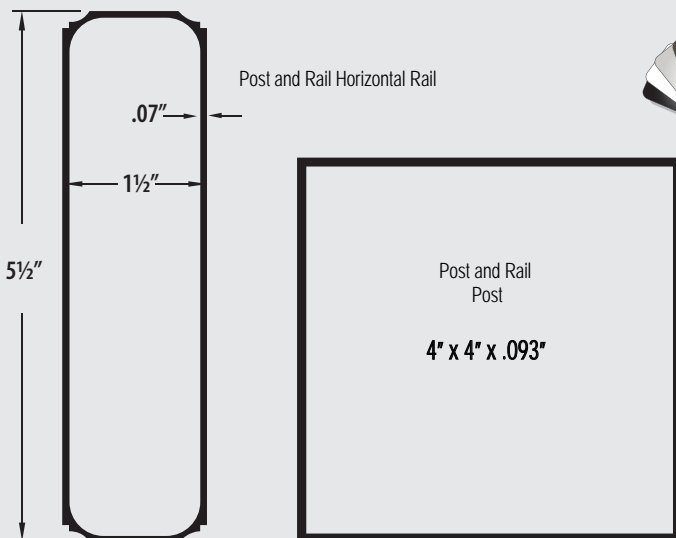

~ Horizontal Rail and Posts
are shown at 1/2 Actual Size

ALUMINUM
FENCE SUPPLY
"The Superior Alternative"

Post and Rail



Series A • Three Channel • Black
Made in the USA



Your Local Stephens Pipe & Steel:

ALUMINUMTM
FENCE SUPPLY
"The Superior Alternative"



Member of the
American Fence Association



North American Fence Contractors Association

